

# 6.200 - Lecture 22

Transfer Functions:

- Transfer Functions
- Gain & Phase
- Bels and Decibels
- Logarithmic Bode Plots

# Transfer Functions

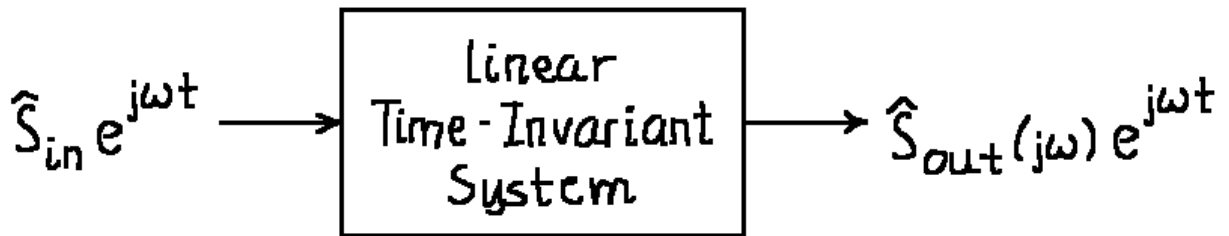

Transfer Function:  $\hat{S}_{out}(j\omega) / \hat{S}_{in} \equiv H(j\omega)$

A reasonably general form for  $H(j\omega)$  is as follows.  
Numerator roots are "zeros". Denominator roots are "poles".

$$H(j\omega) = K (j\omega\tau_0)^{N_0} \frac{\prod_{n=1}^{N_{z1}} (j\omega\tau_{zn} + 1) \prod_{n=1}^{N_{z2}} ((j\omega/\Omega_{zn})^2 + \zeta_{zn}j\omega/\Omega_{zn} + 1)}{\prod_{n=1}^{N_{p1}} (j\omega\tau_{pn} + 1) \prod_{n=1}^{N_{p2}} ((j\omega/\Omega_{pn})^2 + \zeta_{pn}j\omega/\Omega_{pn} + 1)}$$

$$H(j\omega) = |H(j\omega)| e^{j\angle H(j\omega)}$$

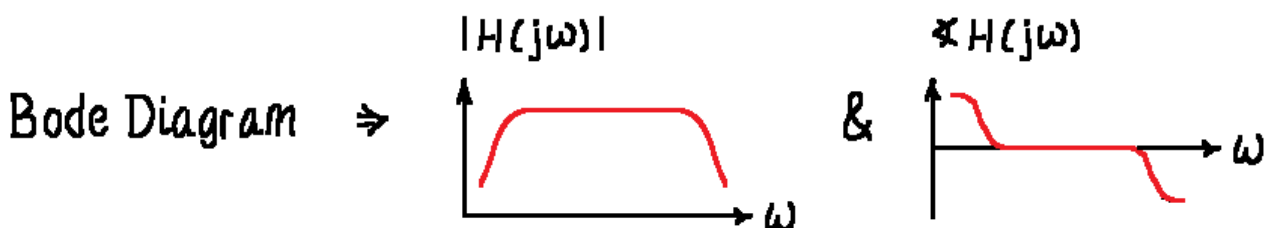
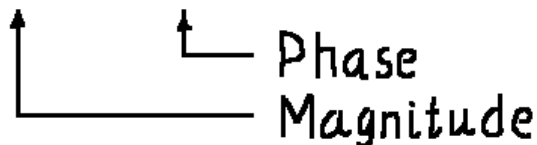

# Magnitude

Common practice is to display  $\log_{10} |H(j\omega)|$  versus  $\log_{10} (\omega/\omega_{\text{ref}})$ . This permits a wide range of magnitude features to be displayed over a wide range of frequencies. It also simplifies the display process.

$$\begin{aligned} \log_{10} |H(j\omega)| &= \log_{10} |K| + N_o \log_{10} |\omega\tau_o| \\ &+ \sum_{n=1}^{N_{z1}} \log_{10} |j\omega\tau_{zn} + 1| - \sum_{n=1}^{N_{p1}} \log_{10} |j\omega\tau_{pn} + 1| \\ &+ \sum_{n=1}^{N_{z2}} \log_{10} |(j\omega/\Omega_{zn})^2 + \zeta_{zn}j\omega/\Omega_{zn} + 1| \\ &- \sum_{n=1}^{N_{p2}} \log_{10} |(j\omega/\Omega_{pn})^2 + \zeta_{pn}j\omega/\Omega_{pn} + 1| \end{aligned}$$

The display of each term above can be determined separately and added graphically to the others.

# Bels [B] & deciBels [dB]

Base 10 logarithmic scales are often used to show features of  $H(j\omega)$  with clarity over a wide range of frequency and amplitude.

The argument of a logarithm should be unitless, so logarithmic scales are scales that are defined relative to a reference. The Bel unit of measurement expresses relative power such that two signals whose strengths differ by 1 Bel [B] have a power ratio of 10. Two signals whose strengths differ by 1 deciBel [dB] have a power ratio of  $10^{0.1}$ . Thus, there are ten 1 dB steps in 1 B. The use of dB is much more common.

The reference for a logarithmic scale must be specified. If left unspecified, a good assumption is 1 W for the reference. Or, the reference could be specified with extra letters. For example, dBW and dBm use 1 W and 1 mW, respectively for a reference.

# dB For Signals

Generally, Power ( $P$ )  $\sim$  Signal<sup>2</sup> ( $S^2$ )

$$\Rightarrow \text{Power Gain} = 10 \log_{10} \left( \frac{P}{P_{\text{Ref}}} \right) \text{ dB}$$

$$= 10 \log_{10} \left( \frac{S^2}{S_{\text{Ref}}^2} \right) \text{ dB}$$

$$= 20 \log_{10} \left( \frac{S}{S_{\text{Ref}}} \right) \text{ dB}$$

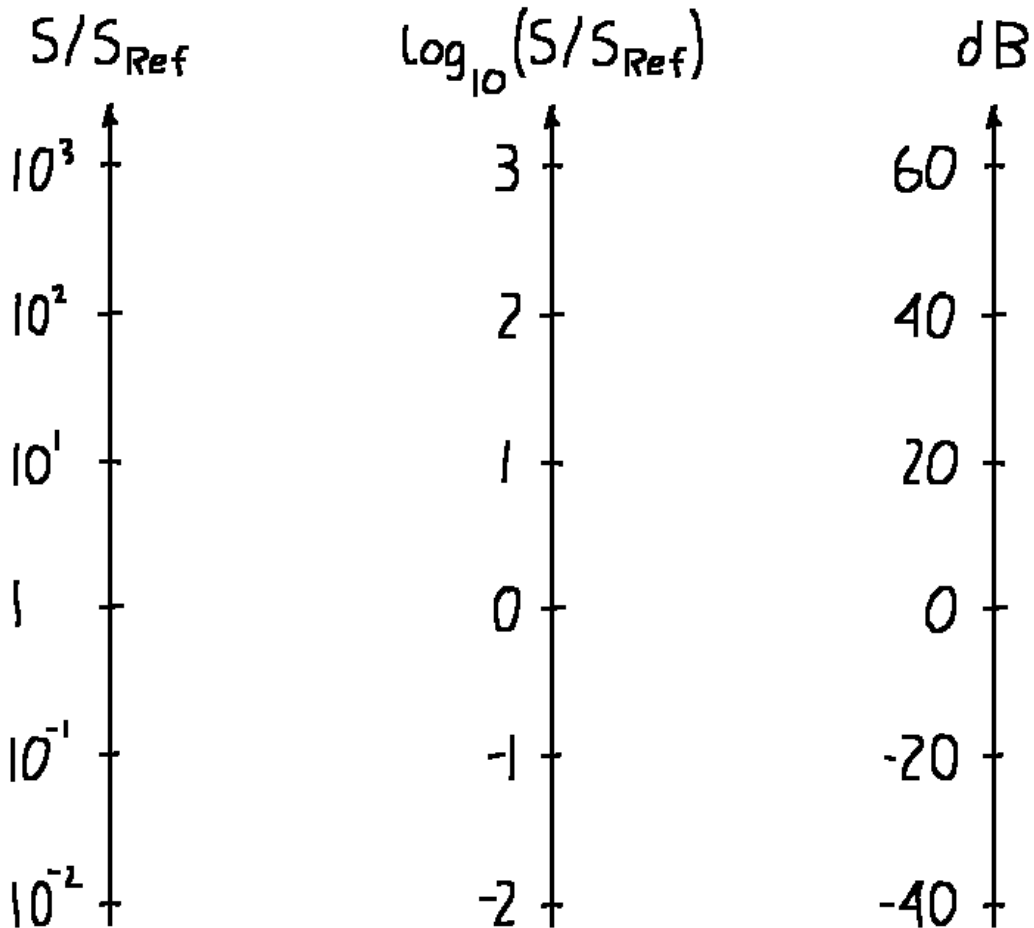

# Phase

Common practice is to display  $\angle H(j\omega)$  versus  $\log_{10}(\omega/\omega_{ref})$ . This permits phase features to be displayed over a wide range of frequencies.

$$\begin{aligned} H_1(j\omega) H_2(j\omega) &= |H_1(j\omega)| e^{j\angle H_1(j\omega)} |H_2(j\omega)| e^{j\angle H_2(j\omega)} \\ &= |H_1(j\omega)| |H_2(j\omega)| e^{j\angle H_1(j\omega) + j\angle H_2(j\omega)} \\ &\Rightarrow \text{Phase adds across products.} \end{aligned}$$

$$\begin{aligned} \angle H(j\omega) &= (\pi/2)(1 - \text{sgn}(K) + N_o \text{sgn}(\tau_o)) \\ &\quad + \sum_{n=1}^{N_{z1}} \angle(j\omega\tau_{zn} + 1) - \sum_{n=1}^{N_{p1}} \angle(j\omega\tau_{pn} + 1) \\ &\quad + \sum_{n=1}^{N_{z2}} \angle\left(\left(j\omega/\Omega_{zn}\right)^2 + \zeta_{zn}j\omega/\Omega_{zn} + 1\right) \\ &\quad - \sum_{n=1}^{N_{p2}} \angle\left(\left(j\omega/\Omega_{pn}\right)^2 + \zeta_{pn}j\omega/\Omega_{pn} + 1\right) \end{aligned}$$

The display of each term above can be determined separately and added graphically to the others.

# Constant & $\omega$ Terms

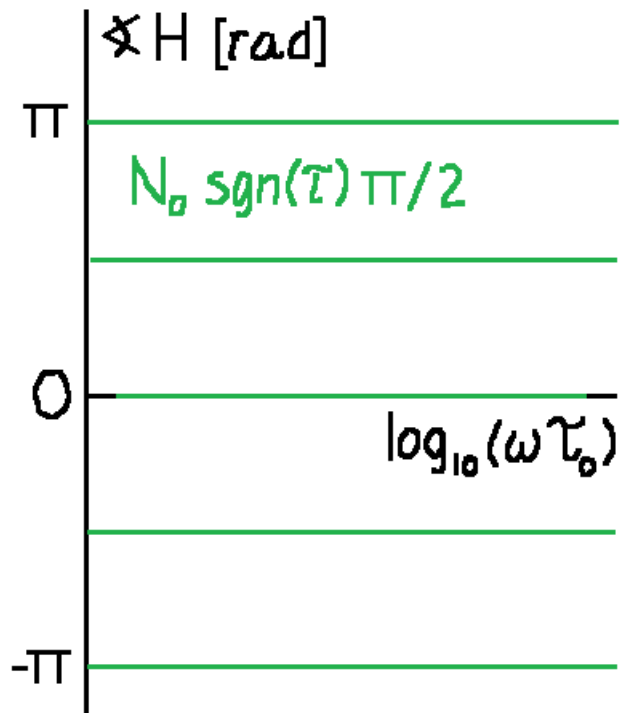
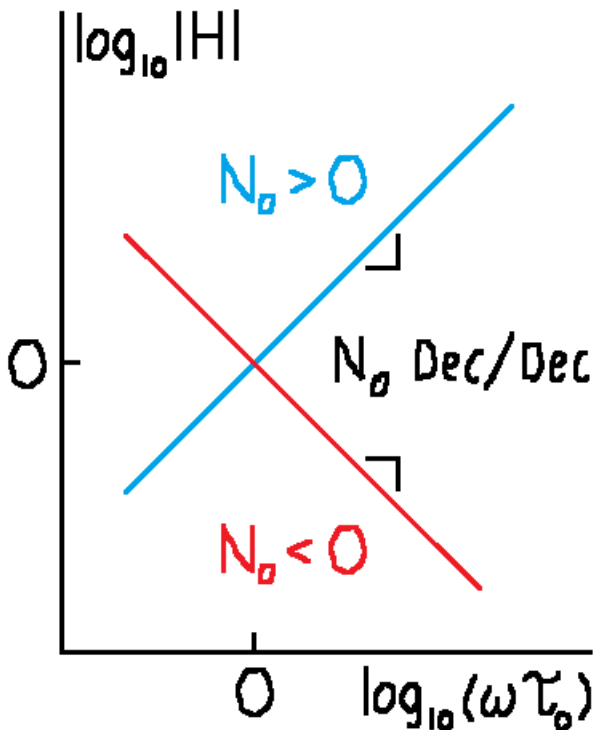
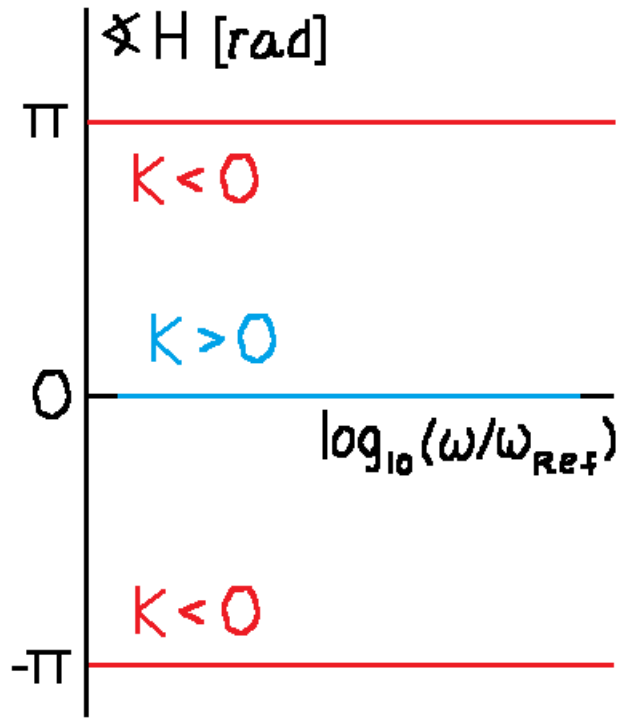
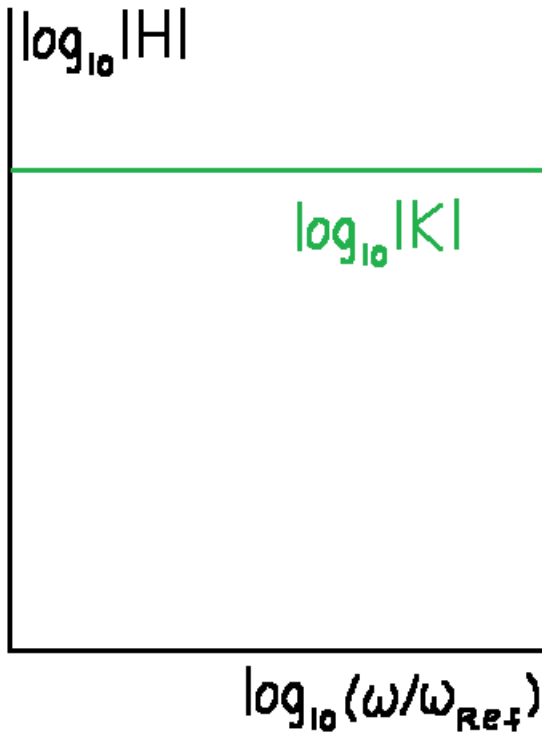

# First-Order Terms

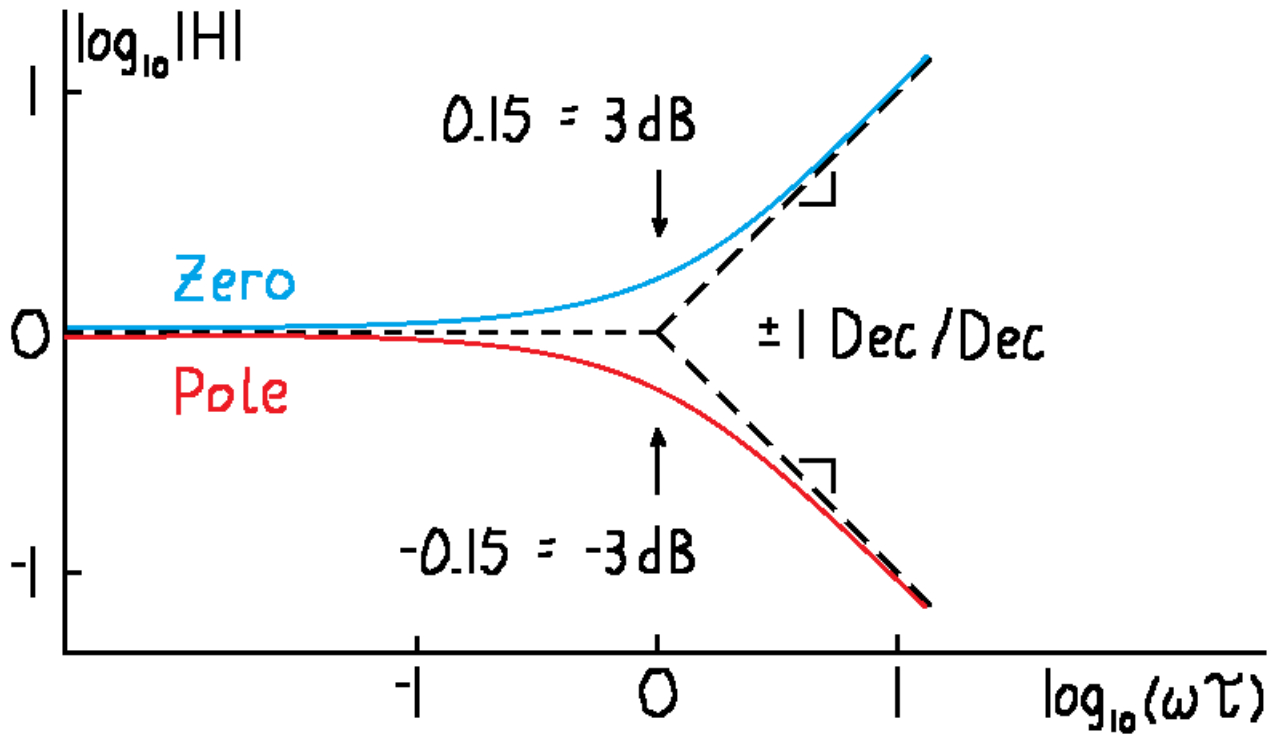

NEED SGN(TAU)

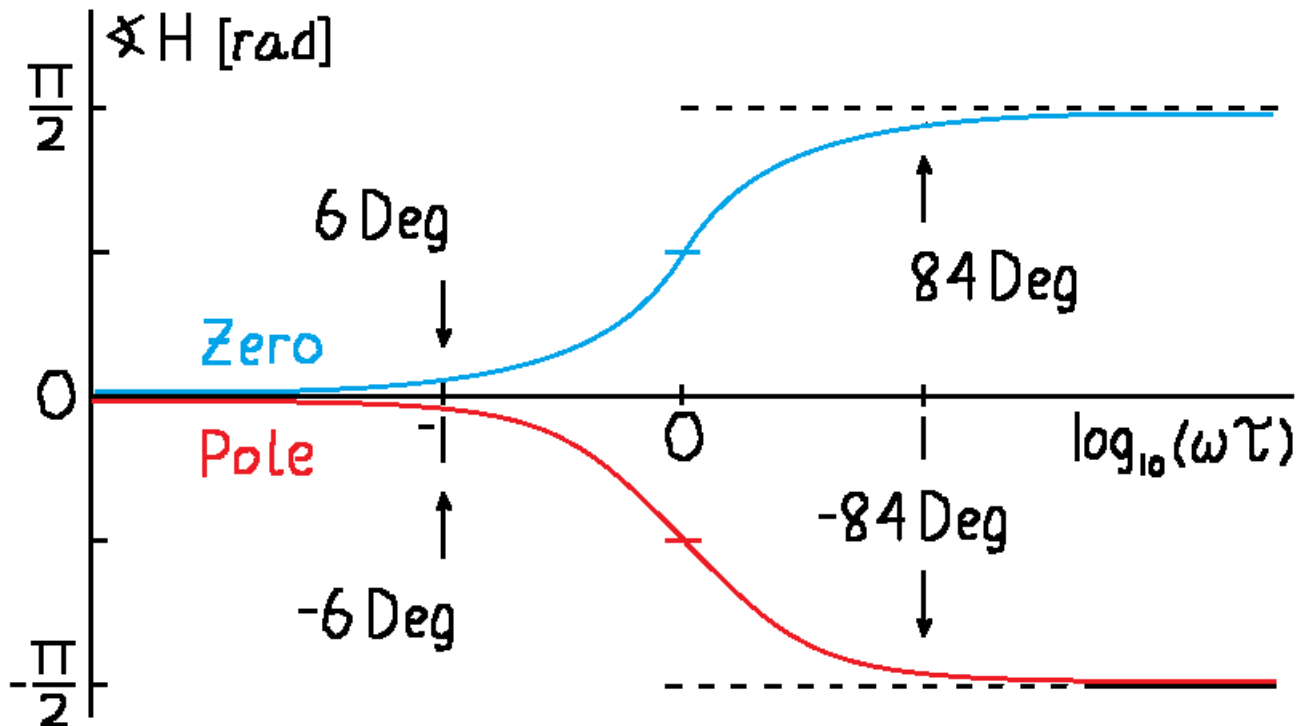

# Second-Order Terms

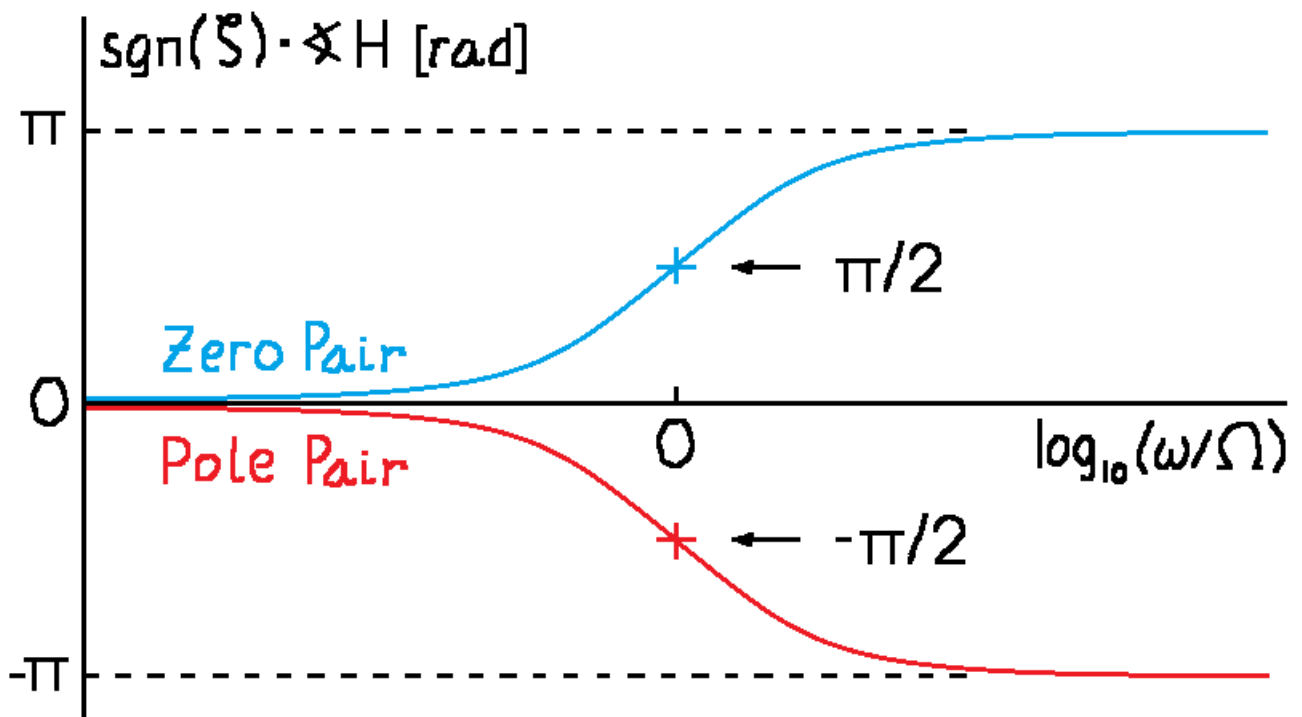
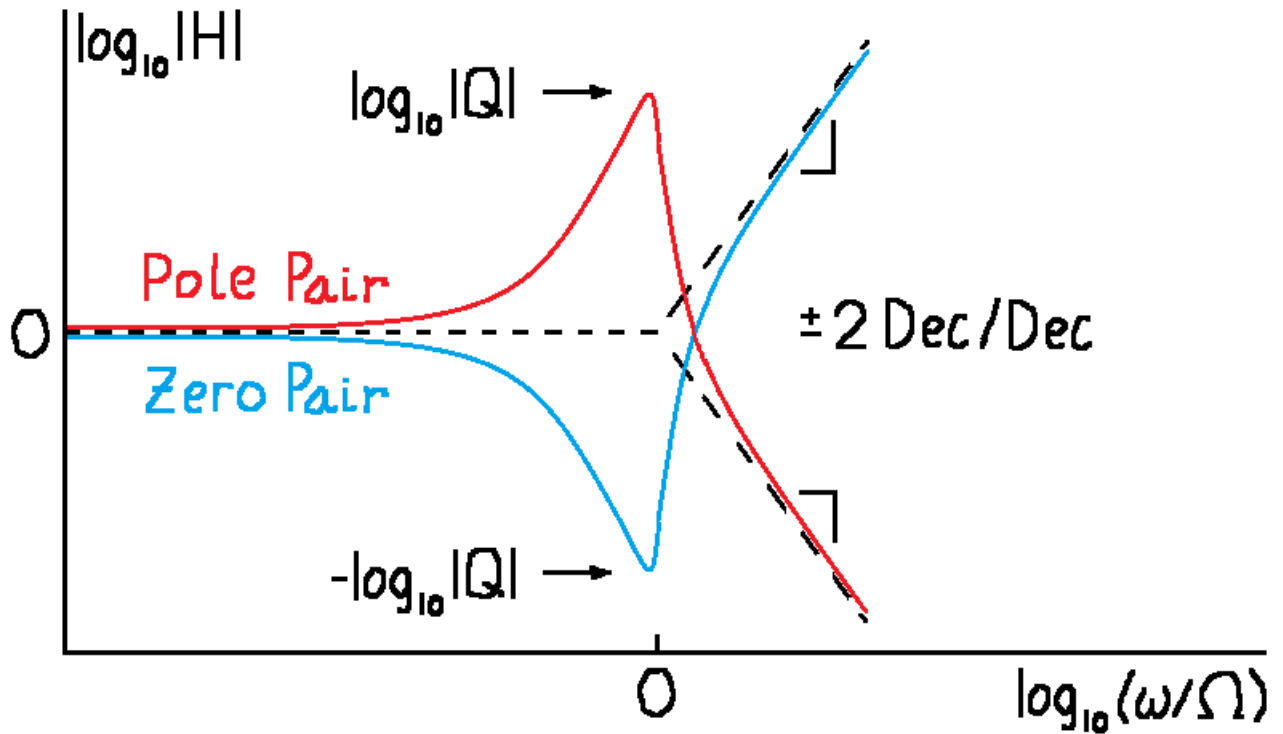

# Op-Amp Filter

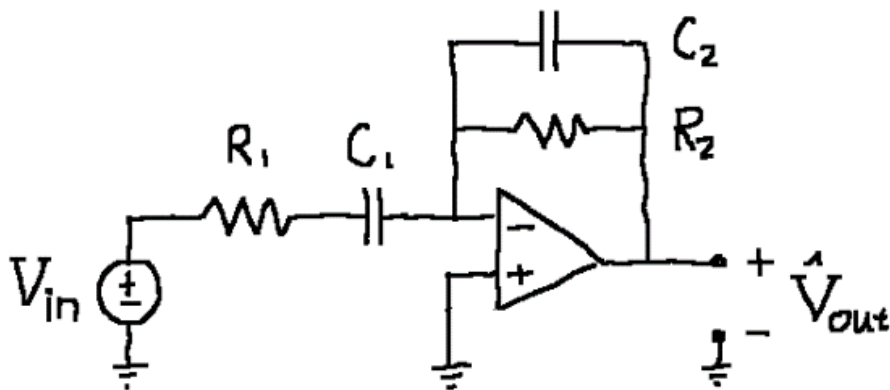

$$\begin{aligned} H(j\omega) &= \frac{\hat{V}_{out}}{V_{in}} = - \frac{R_2 / j\omega C_2}{(R_2 + 1/j\omega C_2)(R_1 + 1/j\omega C_1)} \\ &= - \frac{(R_2/R_1) j\omega C_1 R_1}{(j\omega C_2 R_2 + 1)(j\omega C_1 R_1 + 1)} \end{aligned}$$

Asymptotes: Assume  $R_1 C_1 > R_2 C_2$

$$\text{Low } \omega \Rightarrow H \approx -j\omega C_1 R_2$$

$$\text{High } \omega \Rightarrow H \approx -1/j\omega C_2 R_1$$

$$\text{Mid } \omega \Rightarrow H \approx -R_2/R_1$$

# Op-Amp Filter Bode Plot

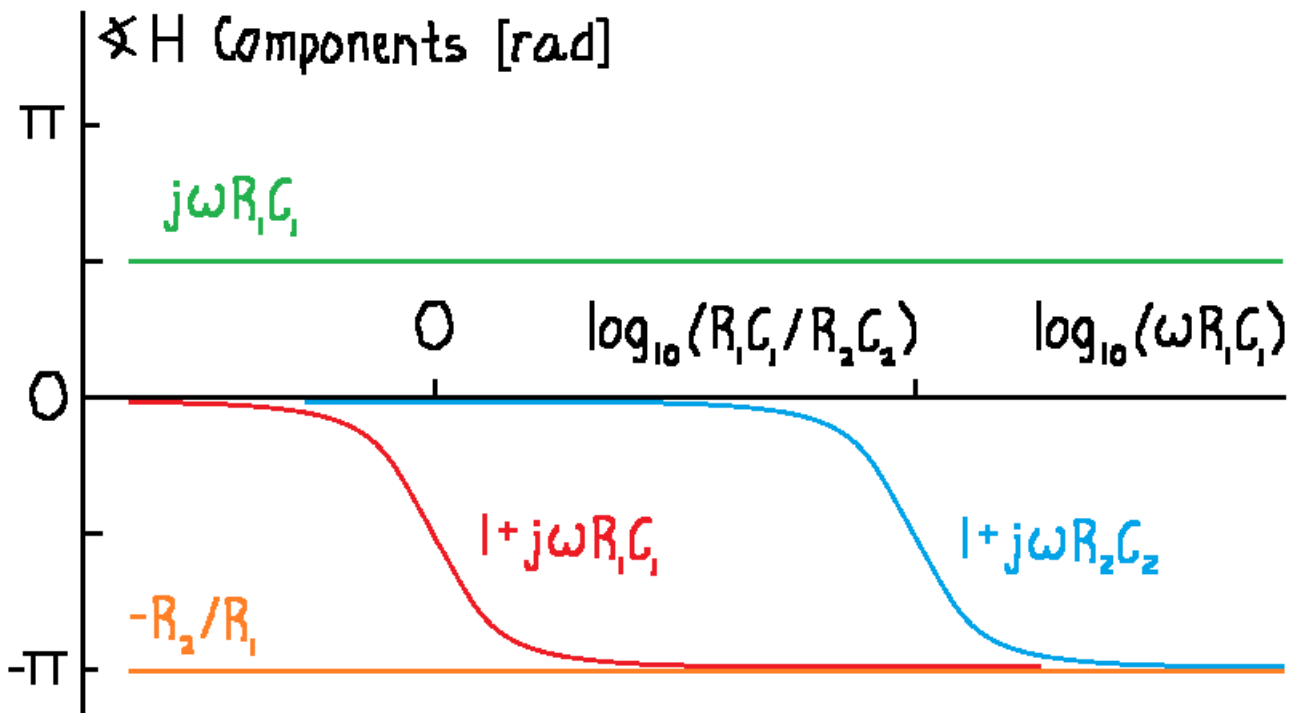
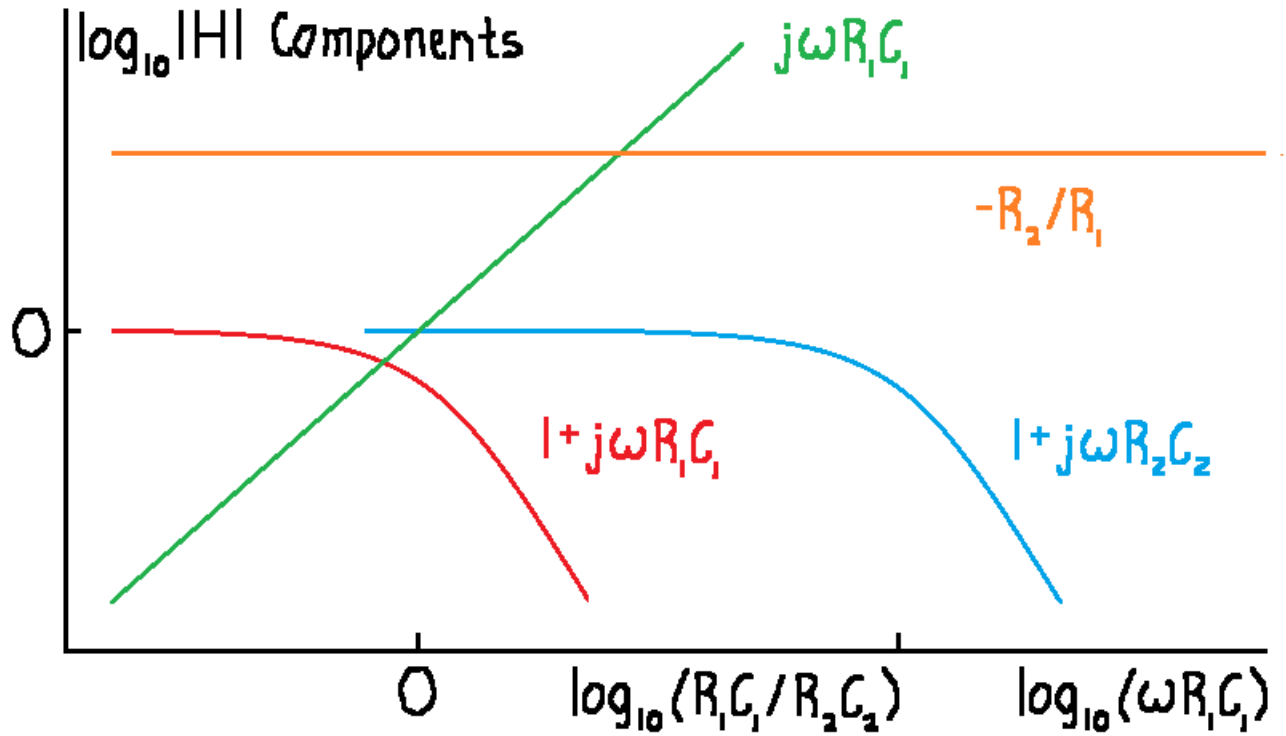

# Op-Amp Filter Bode Plot

